

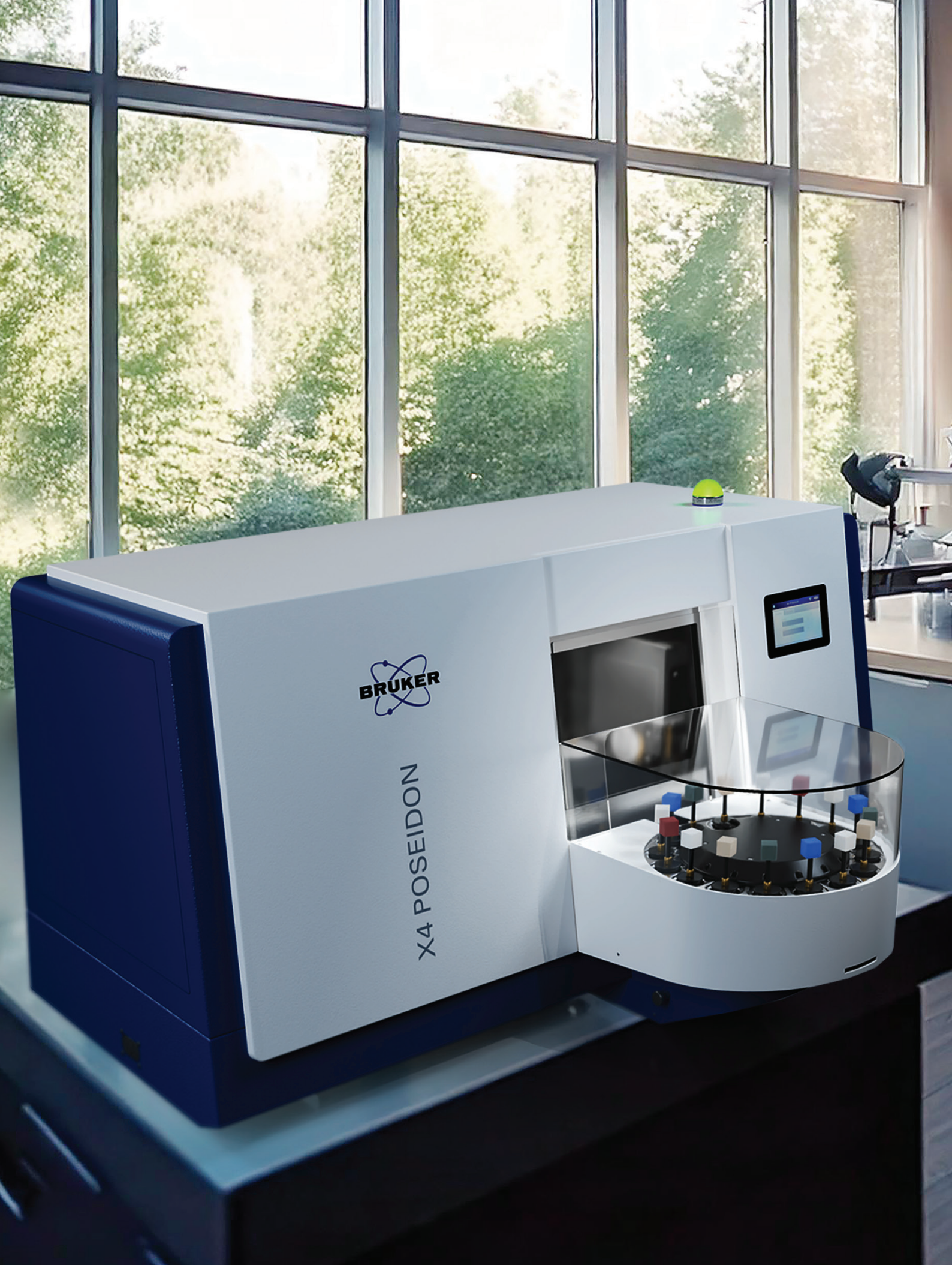

INGENIOUS 3D X-RAY IMAGING
X4 POSEIDON

Modular Benchtop Solution

Innovation with Integrity



BRUKER

X4 POSEIDON

X4 POSEIDON

Modular.
Effective.
Accessible.

The X4 POSEIDON is the first of its kind, applying the platform design of a floor standing system to a compact benchtop. The **modular** hardware and user-centered software can be tailored to any analytical task.

The X4 POSEIDON is extremely **effective** at balancing Field-of-View, Magnification and Speed. Thanks to flagship technology the instrument resolves 2 μm features with razor-sharp contrast. Multi-Vision combines two detectors to create the first multi-scale benchtop microscopy solution, while advanced acquisition algorithms and Geometric Magnification Plus (GEM Plus™) ensure that every 3D image is optimally collected.

The X4 POSEIDON is an **accessible** walk-up system providing unparalleled ease-of-use with a straightforward workflow, an intuitive user interface, and multi-language support. Requiring only standard power and a lab workbench, the X4 POSEIDON fits into any lab, bringing high quality, non-destructive 3D imaging to everyone, everywhere!

The X4 POSEIDON defines a new class of benchtop X-ray Microscopes.

See What Lies Beneath

No analytical technique is as commonplace as microscopy because seeing is believing. Whether using visible light, electrons or atomically sharp cantilevers, these probes are limited to the surface.

X-Ray Microscopy (XRM) is a shift in paradigm, providing a non-destructive three-dimensional view into the microscopic world; giving insight into internal structure and shedding light on the mechanism of failure or confirming successful fabrication.

XRM adds the third dimension to microscopy.

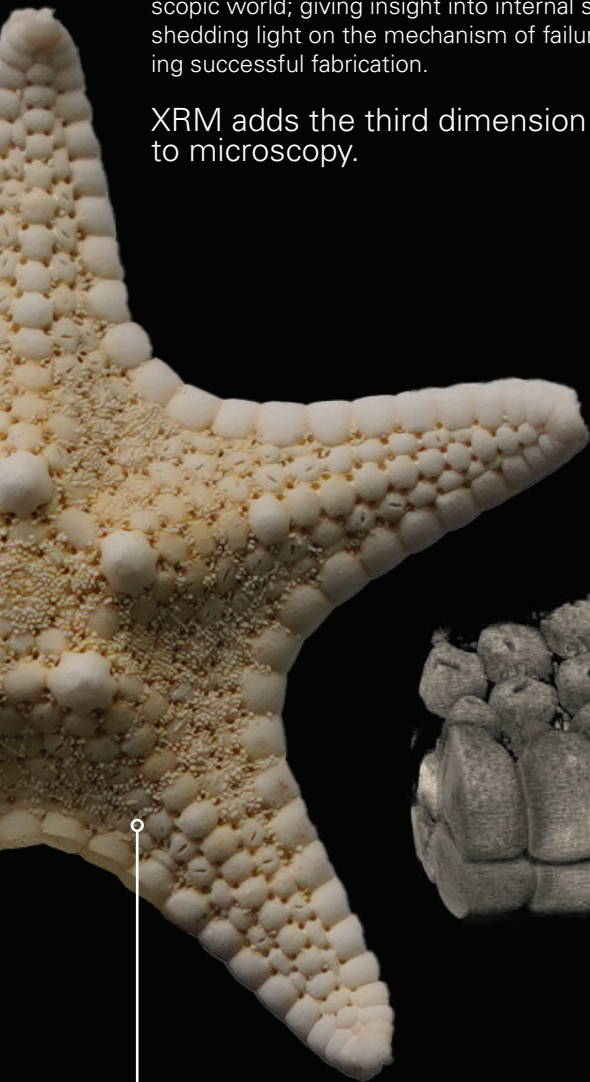

Conventional 2D Microscopy

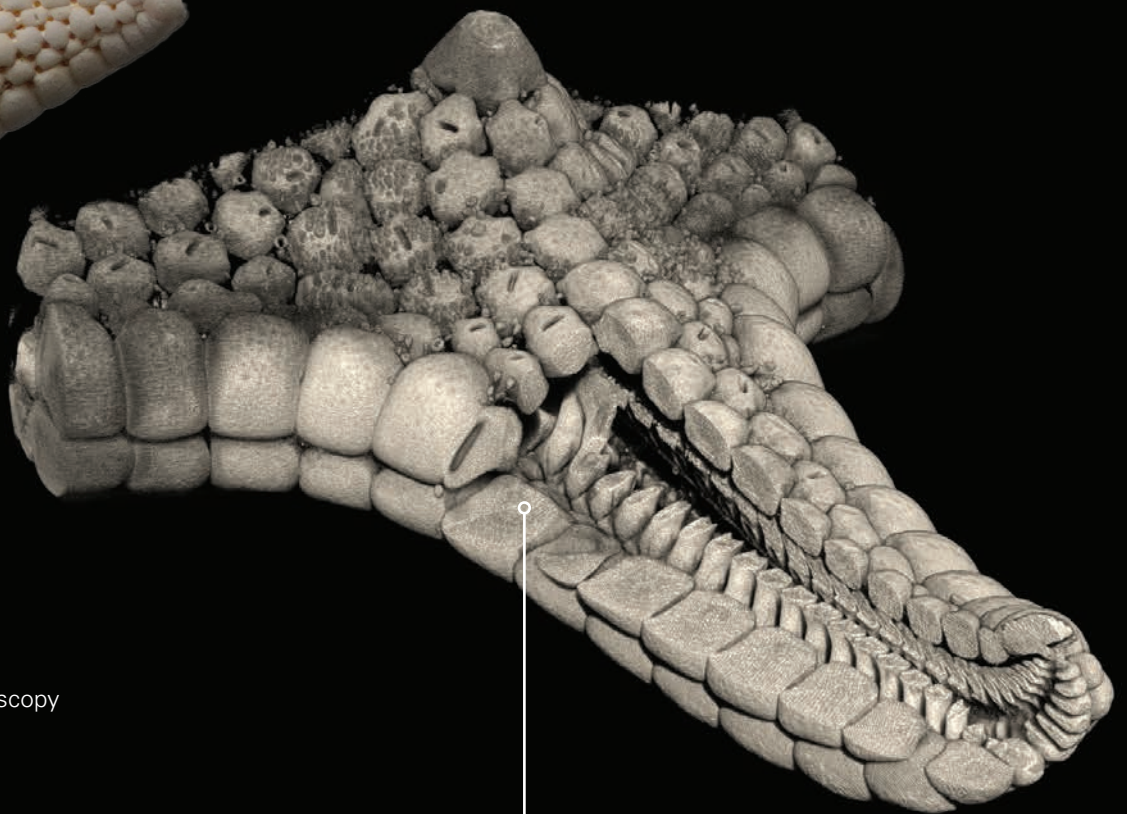

3D X-ray Microscopy



+ INFO
See it in action

The Power of a Platform

The challenges of today often justify the acquisition of analytical equipment, but the long-term value comes from being prepared to answer the unanticipated question of tomorrow. The X4 POSEIDON, as configured at the time of purchase, can be reconfigured as needs change and can integrate new components as technology evolves.

Versatile today, Expandable tomorrow

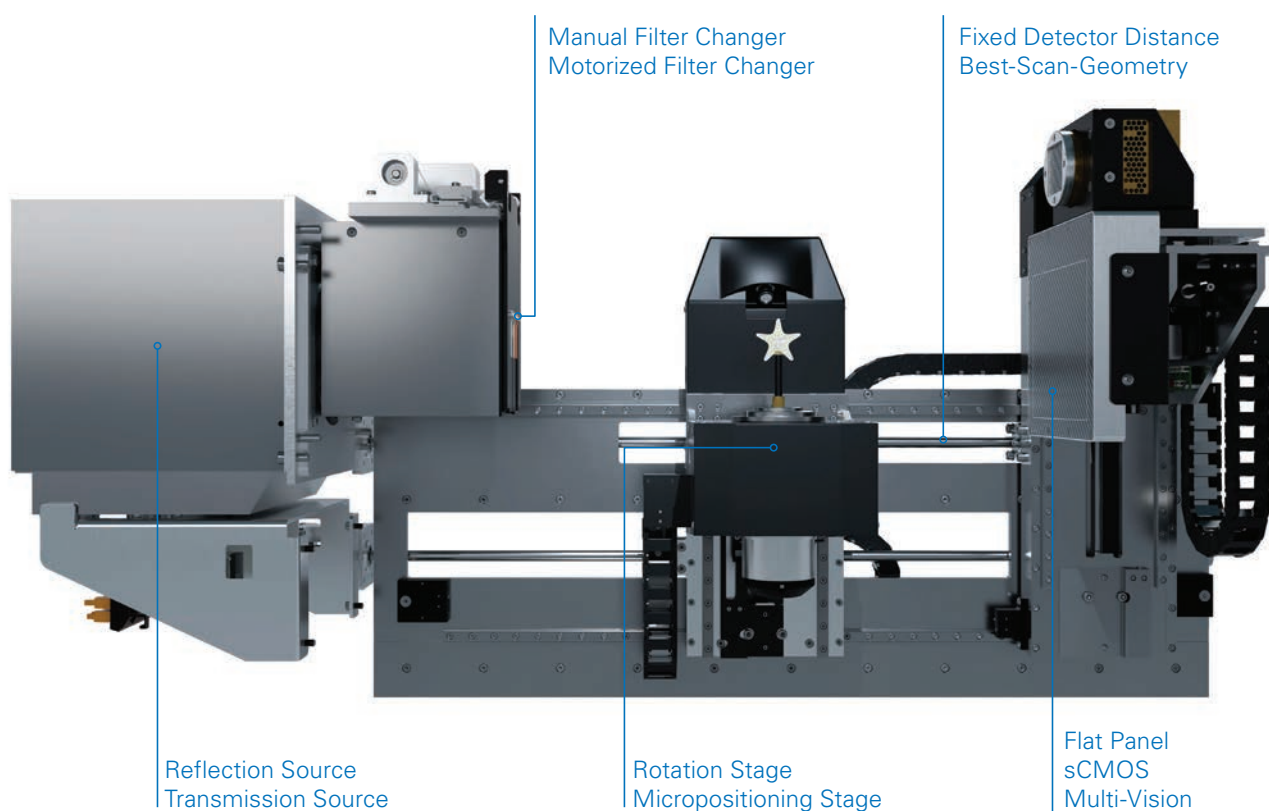

Additional Options

- + Sample Changer
- + Heating Stage
- + Cooling Stage
- + Materials Testing Stage

Geology

- Pore thickness analysis performed on a highly porous sandstone core sample.

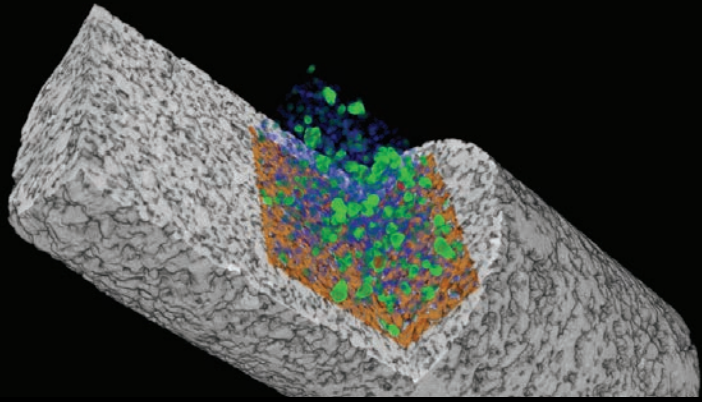

Additive Manufacturing

- Wall thickness of an ultralight-weight titanium 3D-printed sphere for space applications scanned 8 μm voxel size.

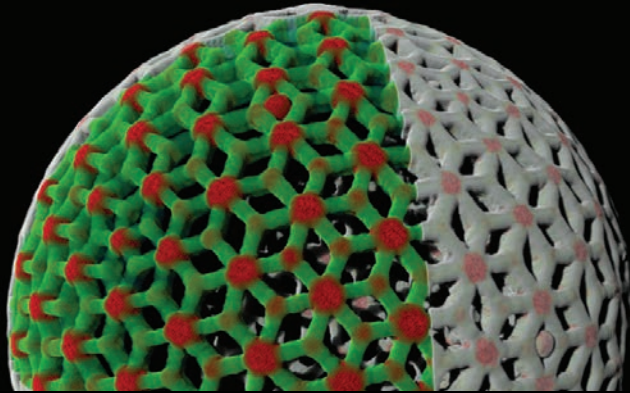

Pharmaceutical

- XRM is utilized to non-destructively investigate micro granules inside a hard capsule.

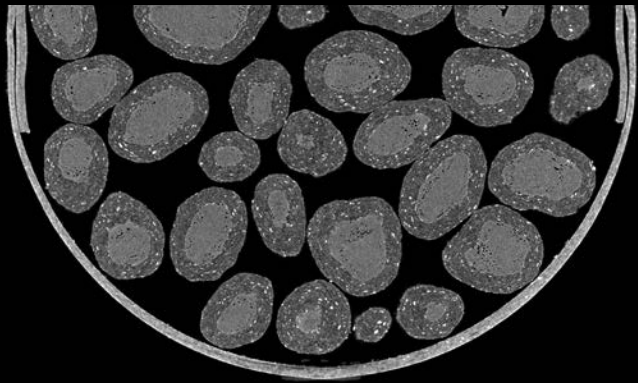

Energy Storage

- Structure thickness analysis of the porous layer deposited on the carbon cloth section of a Gas Diffusion Layer (GDL) in a fuel cell.

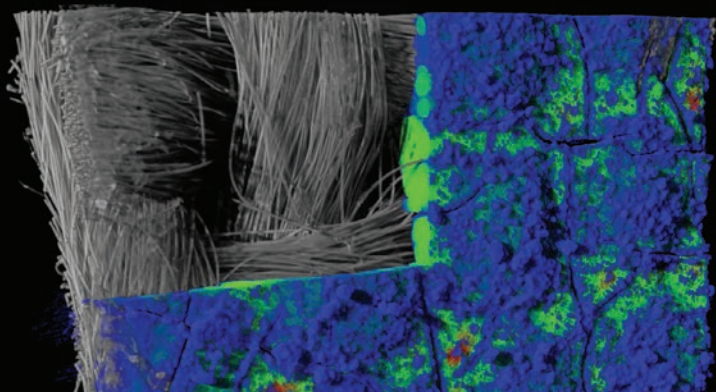

Quality Control

- High-throughput quality control on a lens used in smartphone cameras, scan performed in 2 minutes at 8 μm voxel size.

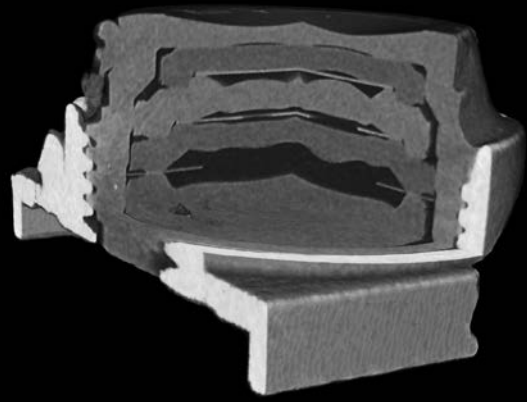

Composite Materials

- Fiber orientation analysis performed on the carbon fibers inside a Carbon Fiber Reinforced Polymer (CFRP) scanned at 600 nm voxel size.

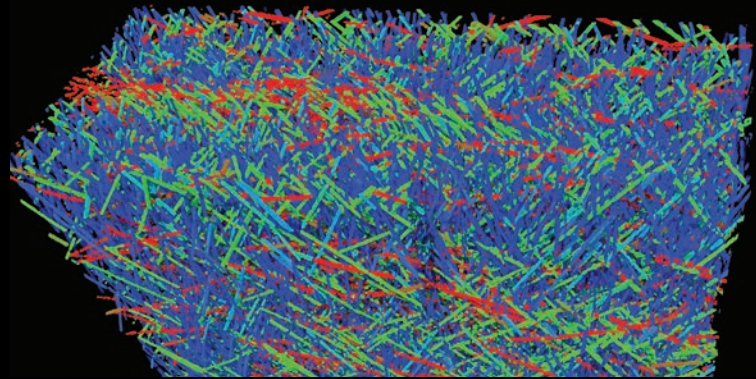

Food Science

- XRM is used to investigate and characterize the key structure properties of a delicious chocolate covered "pepernoot" cookie, a traditional and popular sweet offer at Sint Niklaas period in The Netherlands.

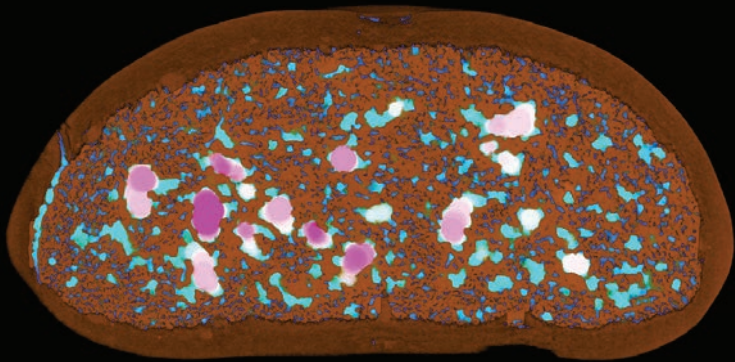

Electronics

- Structure thickness analysis of the internal components of an electronic chip to determine if they are within specification.

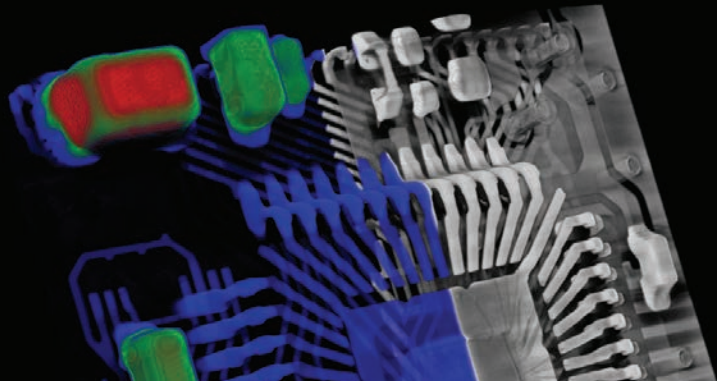

+ INFO
Discover more applications

X4 POSEIDON

Comprehensive from the Start

The X4 POSEIDON is a comprehensive solution from the start featuring many premium features to enhance the user experience. In its essential configuration the X4 POSEIDON includes a proven reflection X-ray source and versatile flat-panel detector. With these components, the system is capable of ultra-fast scanning with exceptional field-of-view and razor-sharp contrast without compromising resolution.

Whether your lab supports multiple users in diverse research and development fields or a specific industrial process, the X4 POSEIDON offers the full power of non-destructive, qualitative and quantitative 3D analysis.

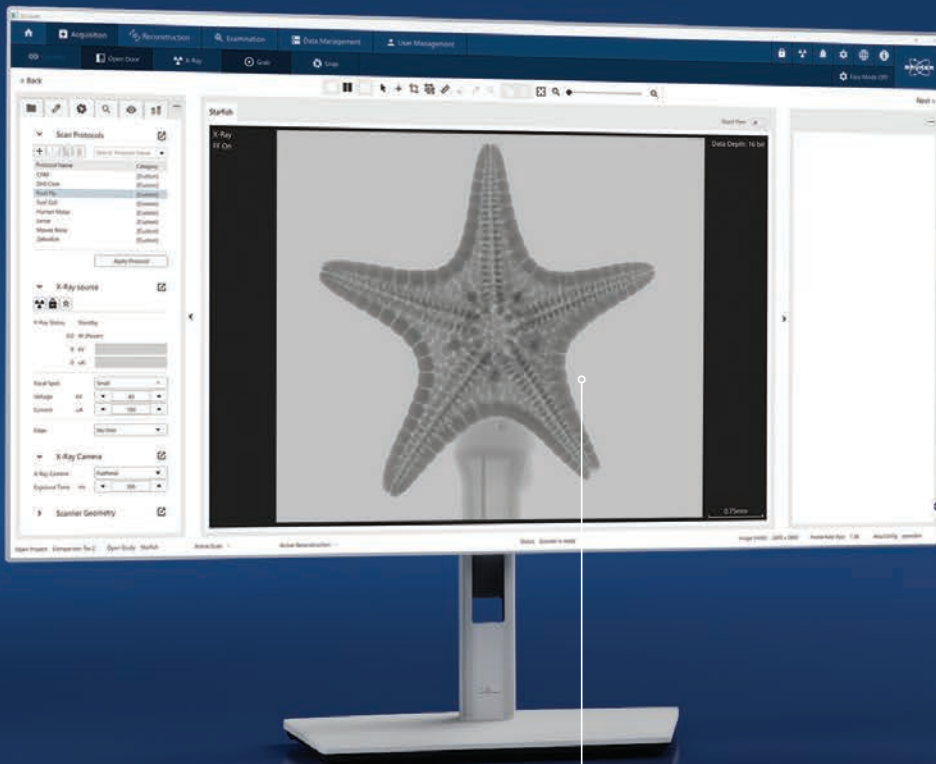

User Centered Software

Feedthrough

Compact Enclosure

Motorized Lead Glass Door

Touch-screen

Multi-function status Light

Safety Light Curtain

Comprehensive Safety

Standard Power
No Water

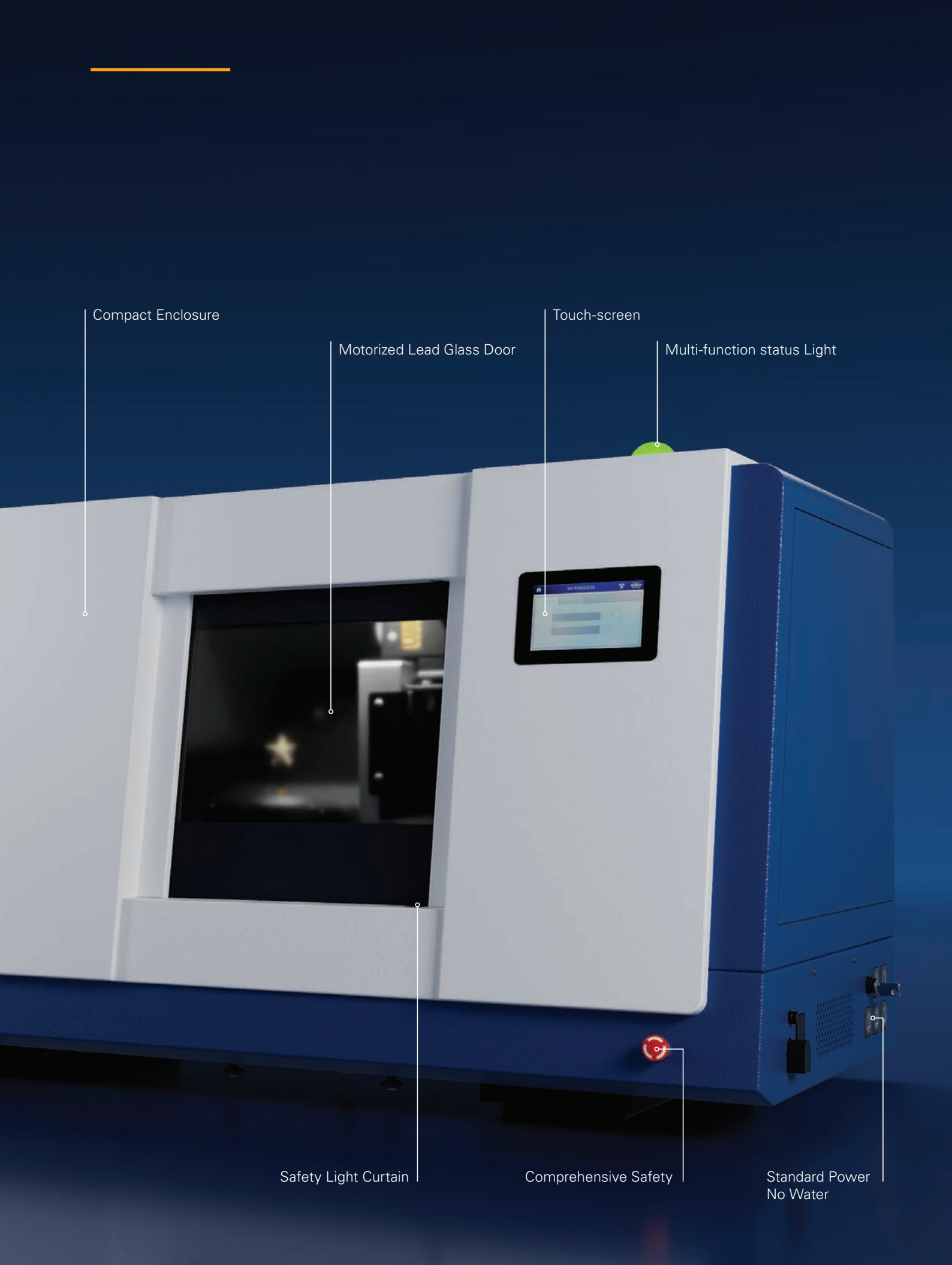

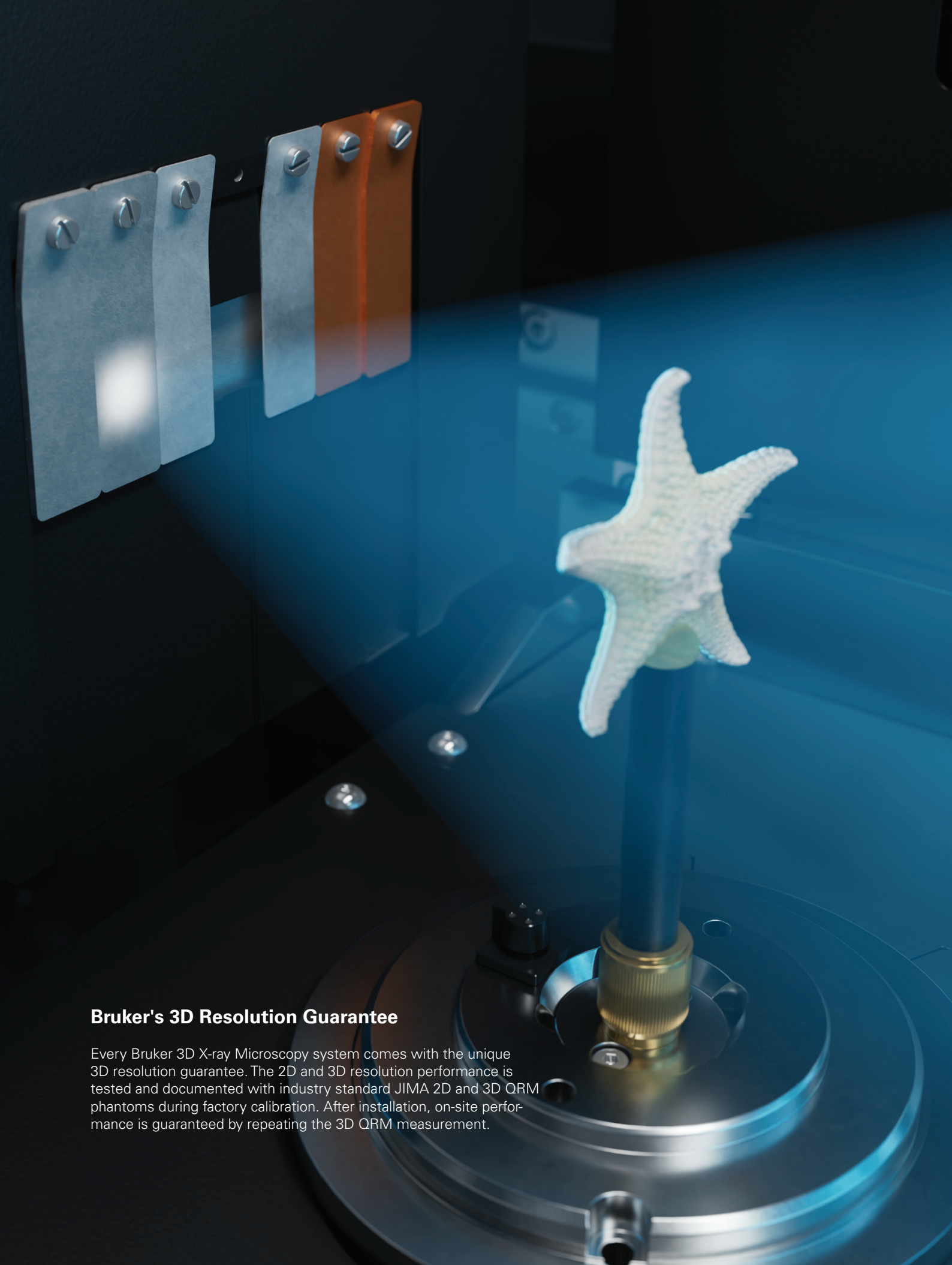

Bruker's 3D Resolution Guarantee

Every Bruker 3D X-ray Microscopy system comes with the unique 3D resolution guarantee. The 2D and 3D resolution performance is tested and documented with industry standard JIMA 2D and 3D QRM phantoms during factory calibration. After installation, on-site performance is guaranteed by repeating the 3D QRM measurement.

Brilliant X-ray Power

The X4 POSEIDON supports the latest generation of microfocus X-ray sources.

The **reflection X-ray source** produces an X-ray beam with energy up to 100 kV and 20 W power. This industry-grade source is the perfect choice for your workhorse solution in a multi-user facility, service lab or screening environment. It requires no maintenance and feature a low cost of ownership.

The **transmission X-ray source** achieves a 2 μm spot size and is the perfect research solution to obtain high-resolution data. A maximum energy of 110 kV extends the application range to higher density and larger samples.

The X4 POSEIDON platform allows on-site source exchange as your needs evolve over time.

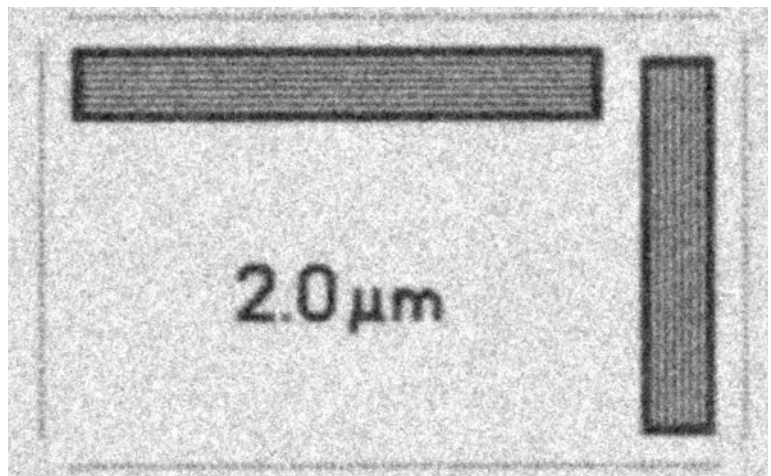

2D JIMA standard collected with transmission source and sCMOS detector

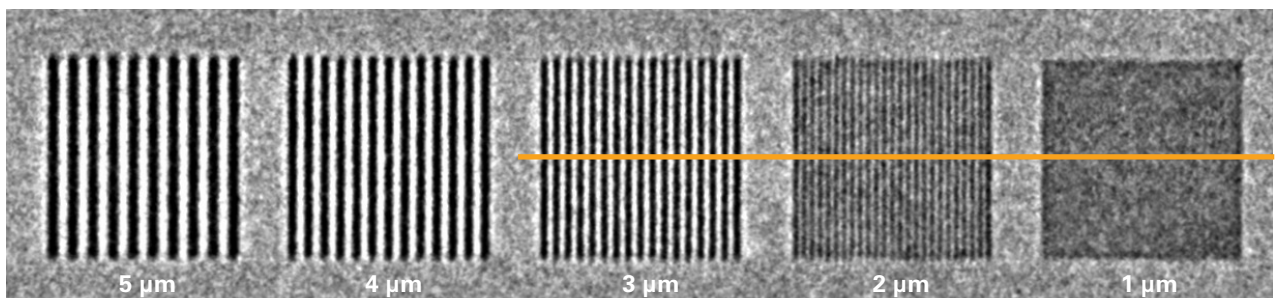
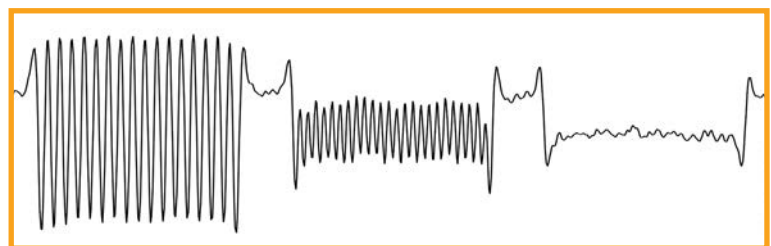
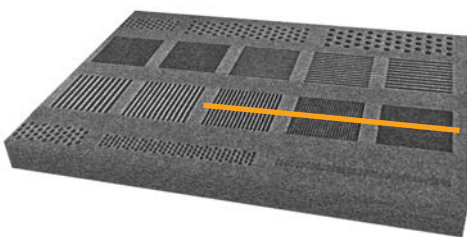

3D QRM standard collected with the transmission source and sCMOS detector. 3D reconstructed volume (top left), extracted slice (bottom) and integrated line (top right)

Multi-Vision

A Sharp Eye on your Sample

The X4 POSEIDON is the only true multi-detector benchtop XRM solution. It can be equipped with a versatile flat-panel detector, a scientific-grade CMOS detector, or BOTH!

When selecting the ideal detector for your needs, you must consider the balance of field-of-view, resolution and scan speed. If speed is of utmost importance, the flat-panel detector is ideally suited for your application. On the other hand, the sCMOS detector is the ideal choice for maximum resolution. With the X4 POSEIDON a choice does not have to be made. Thanks to Multi-Vision you can have both!

As with the source, the X4 POSEIDON platform allows on-site upgrade to Multi-Vision.

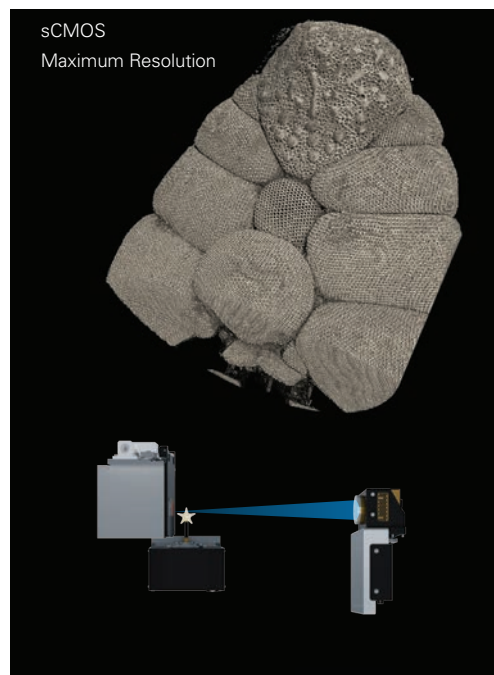
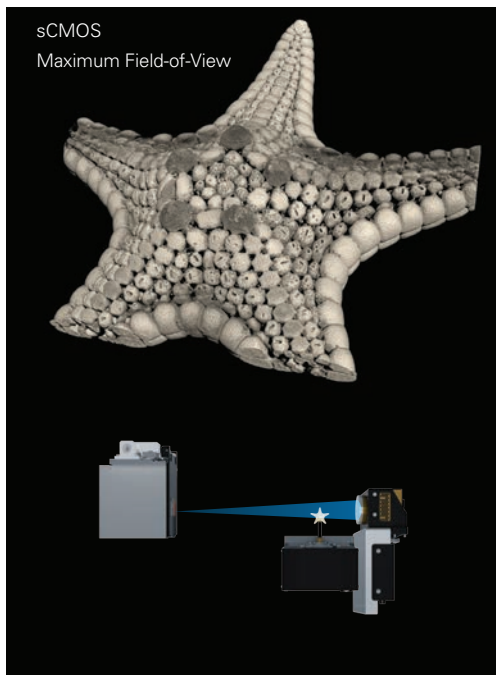
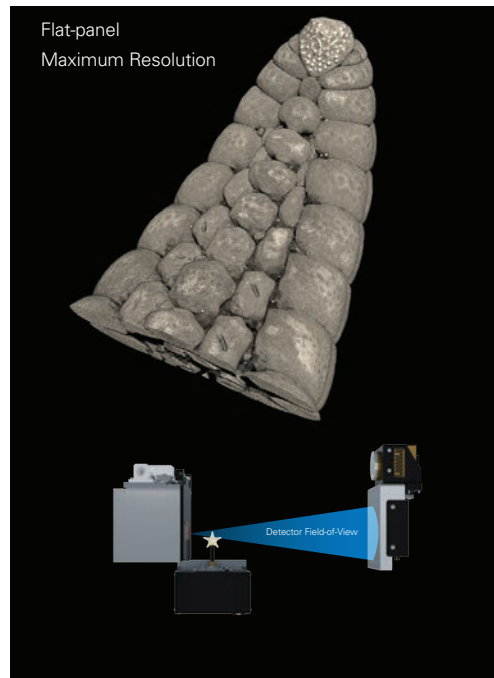
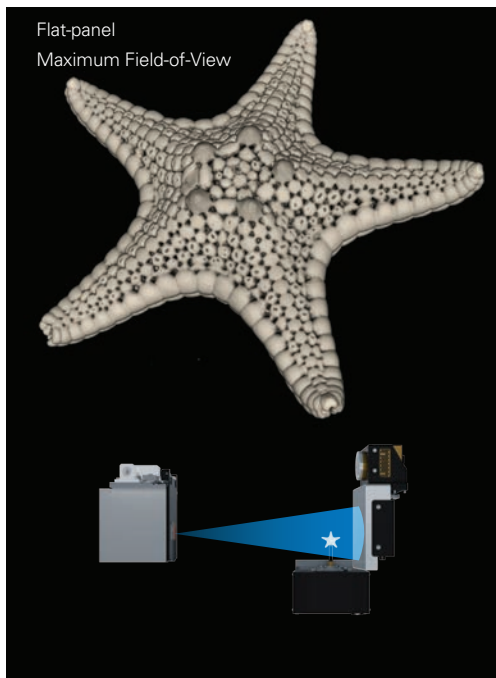

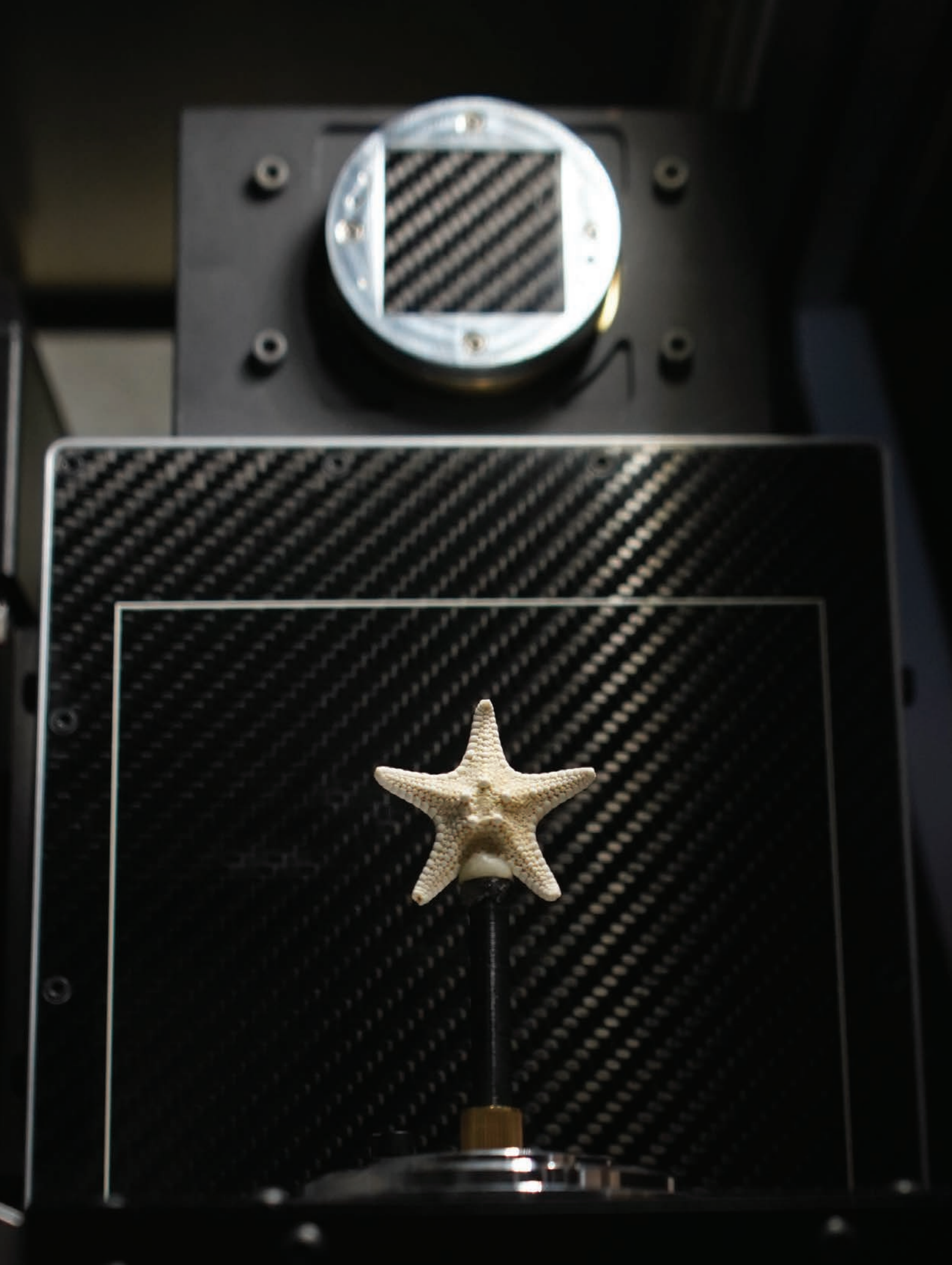

Traditional Geometric Magnification

Degrees of Freedom

- Sample Position

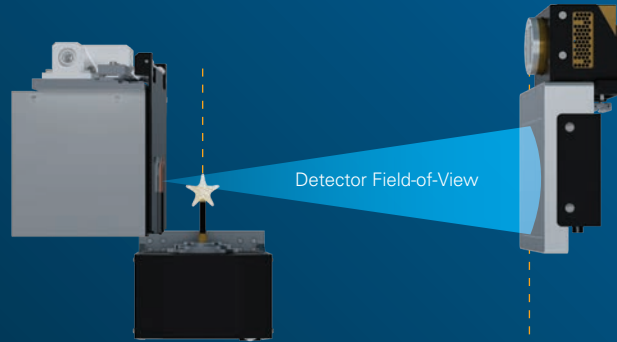

GEM Plus

Degrees of Freedom

- Sample Position
- Detector Selection
- Detector Position

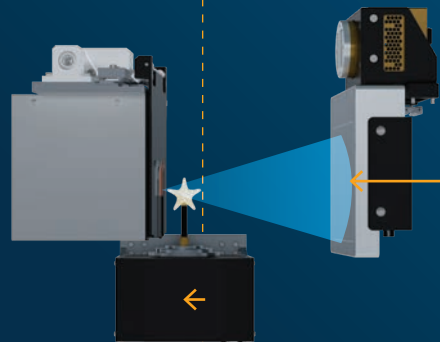
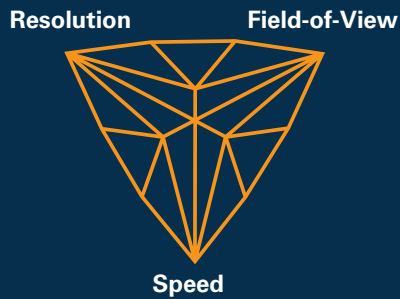

4x Faster*
Similar Resolution
Similar Field-of-View

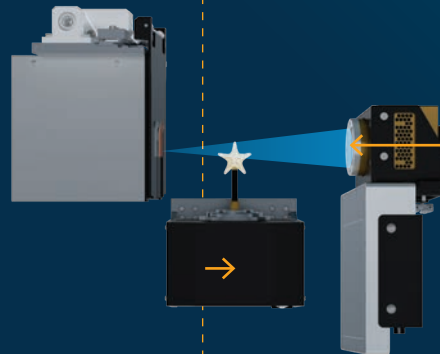

1.5x Sharper*
Similar Speed
Similar Field-of-View

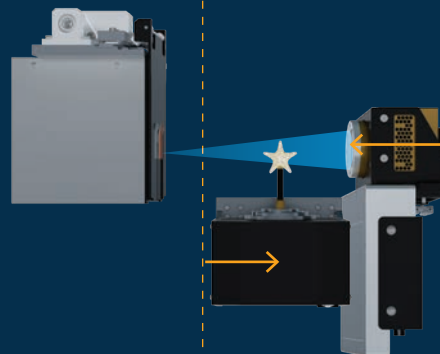

1.5x Larger*
Similar Speed
Similar Resolution



+ INFO
See it in action

*Compared to Traditional GEM

GEM Plus

Strike the Perfect Balance

By combining Best-Scan-Geometry and Multi-Vision, the X4 POSEIDON delivers ultimate flexibility in a benchtop with Geometric Magnification Plus.

A balance of field-of-view and resolution is achieved by moving the sample closer to the source or closer to the detector. With Best-Scan-Geometry, the detector can also be moved in a continuous way, allowing ideal cone beam utilization for a given sample size while achieving the same magnification ratio resulting in a significant scan speed improvement.

GEM Plus builds on Multi-Vision and Best-Scan-Geometry to strike the perfect balance between pure resolution, scan speed and field-of-view.

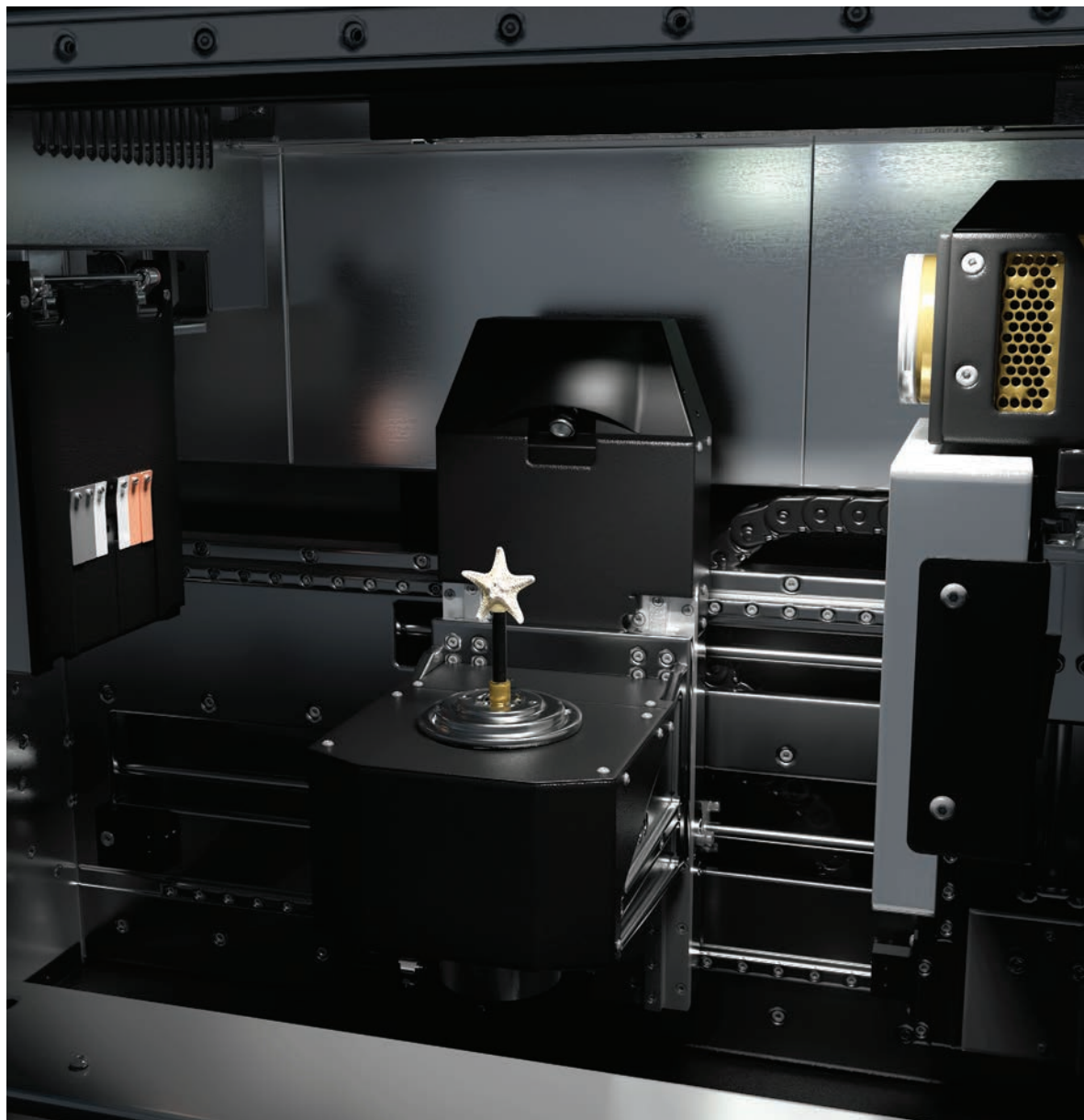



+ INFO
See it in action

Optimize Productivity

The X4 POSEIDON can be upgraded with a 15-position sample changer to maximize instrument usage and minimize operator interaction.

The compact sample changer is ergonomically positioned in front of the instrument. The status of each position is indicated by an LED allowing sample addition or replacement at any time, even during operation. The intelligent loading algorithm (patent pending) optimizes sample throughput.

Each position accommodates samples up to 50 mm diameter and 80 mm height. Small samples can be stacked vertically and bundled to increase capacity.

When not in use, the sample changer can stay installed while having full access to the instrument for loading large samples or specialty stages.

4D XRM Flawlessly Integrated

Enhanced throughput by source power, detector speed efficiency, variable geometry and advanced scanning modes opens new possibilities for in situ 4D experiments using proprietary specialty stages.

The Bruker material testing stages can perform compression and tensile experiments up to 4400 N and 440 N, respectively, while Bruker's heating and cooling stages can reach temperatures of 30 °C below ambient to 80 °C. All stages are integrated into the software and hardware eliminating the need for cables.

A cable feedthrough in the enclosure allows use of custom or third party stages.

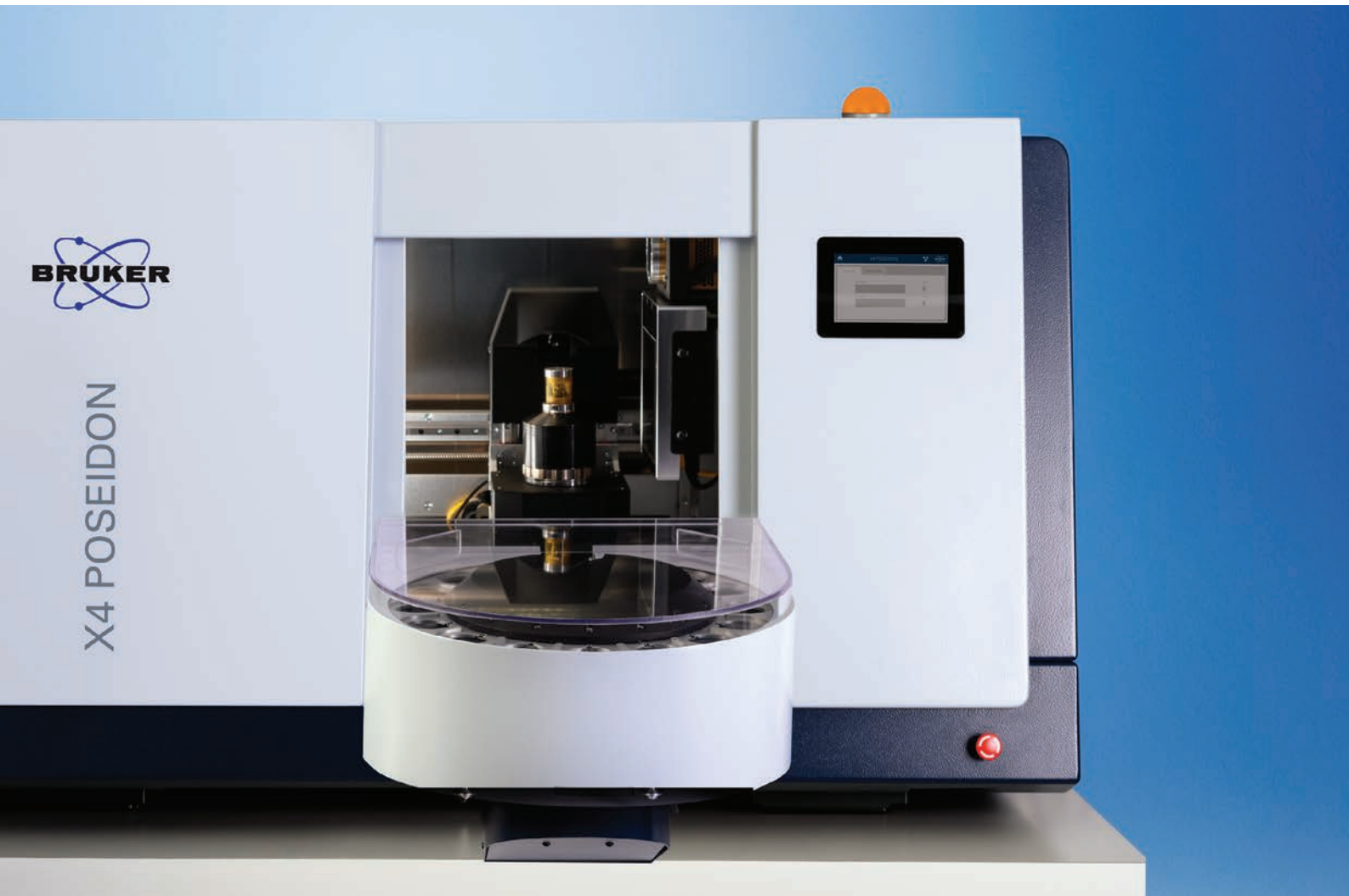

User-centered 3DxSUITE Software

Intuitive, simple, yet powerful – the 3DxSUITE software is designed to inspire finding out what's inside. Its user-centered design ensures even a novice user can easily start imaging.

- Architecture allows easy extension of hard- and software
- User and data management
- Adaptable flexible graphic user interface
- Multi-language support
- Standard includes 3D examination, visualization, and analysis
- Phase retrieval algorithms reveal features that would remain hidden with standard absorption contrast
- Advanced scan algorithms ensure the best image quality

3DxSUITE. The turn-key measurement and analysis solution.

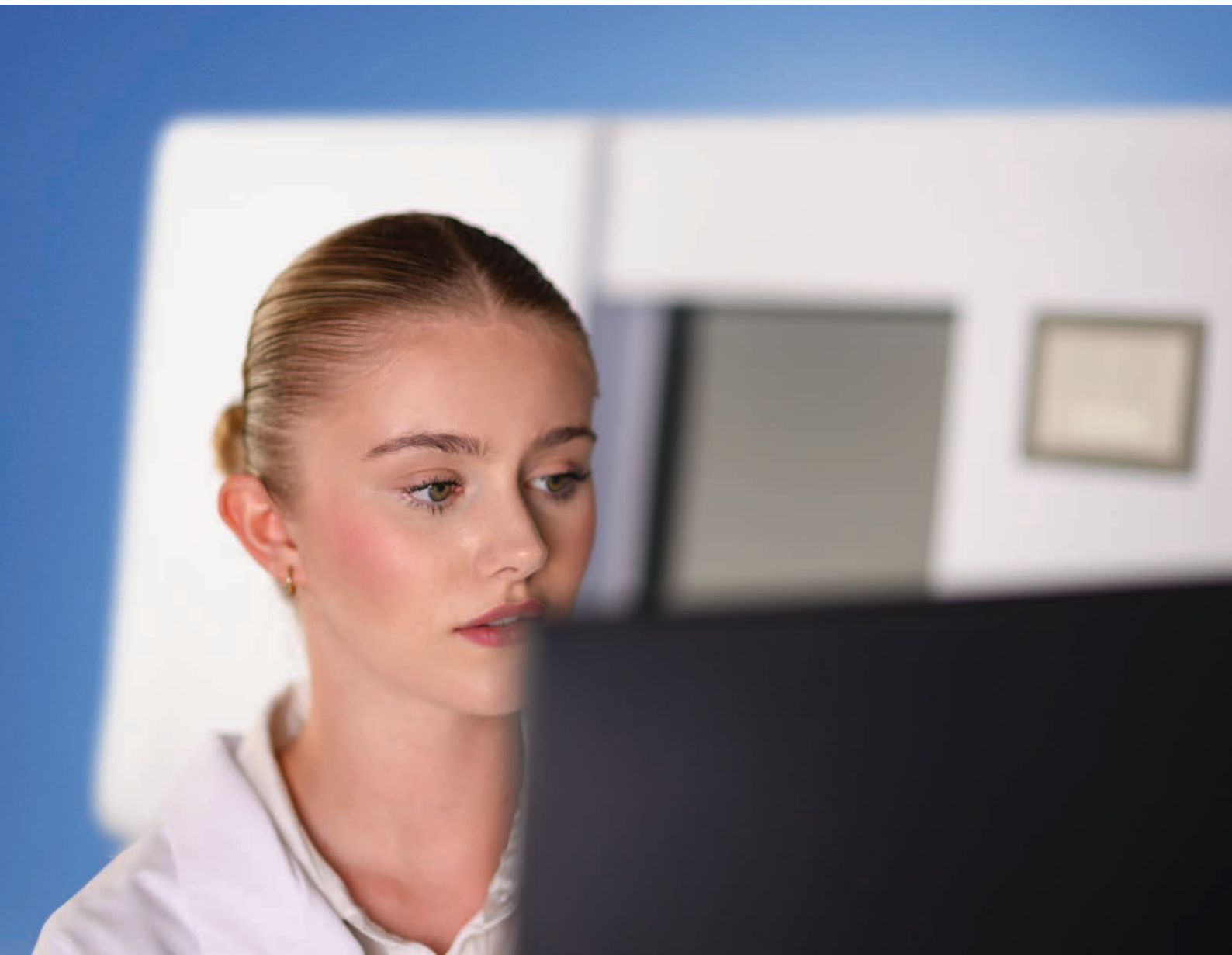

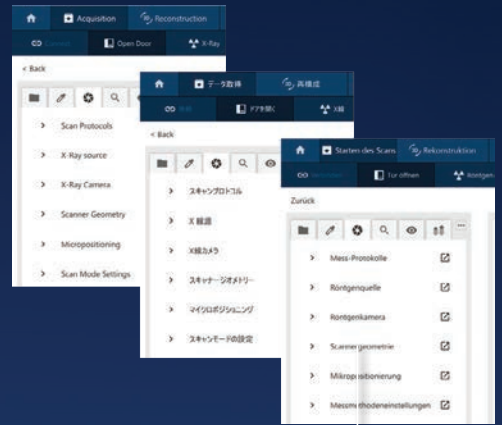

Organized Data Storage

Control User Access

Multi-language Support

Simplify User Workflow

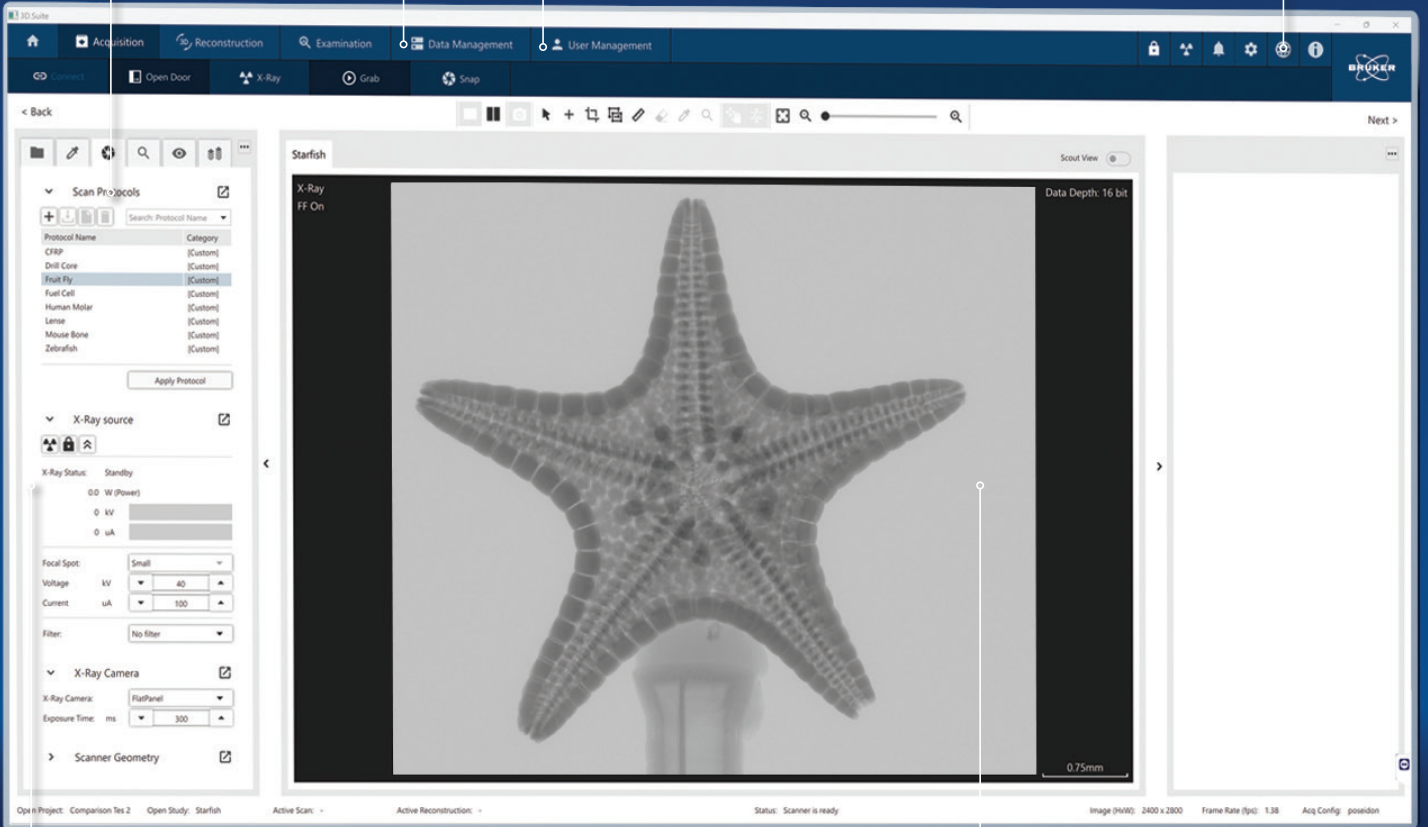

Complete Expert Control

Real-time Projection Image

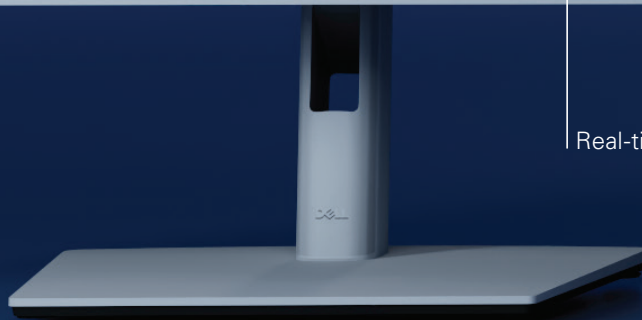

Bruker Imaging Solutions

With over 6 decades of experience designing, building and supporting analytical solutions for routine industrial applications and cutting-edge research, Bruker is the ideal partner for a long-term analytical investment. With a global network of application and service professionals, we are always ready to support your success.

Bruker imaging solutions cover a wide range of technologies including:

- X-ray Microscopy
- Micro X-ray Fluorescence Mapping
- Magnetic Resonance Imaging
- Scanning Tunneling Electron Microscopy
- Atomic Force Microscopy
- Raman Microscopy
- Fourier Transform Infrared Microscopy
- Fluorescence Microscopy
- Light Sheet Microscopy
- Molecular Imaging



+ INFO
Learn more

Bruker AXS is continually improving its products and reserves the right to change specifications without notice.
Order No. DOC-B76-EX5018. © 2025 Bruker AXS SE.

Bruker AXS SE
Östliche Rheinbrückenstraße 49
76187 Karlsruhe
Germany

info.baxs@bruker.com
bruker.com

Worldwide offices
bruker.com/baxs-offices

Online information
bruker.com/x4poseidon

